

UN47S
UN47P

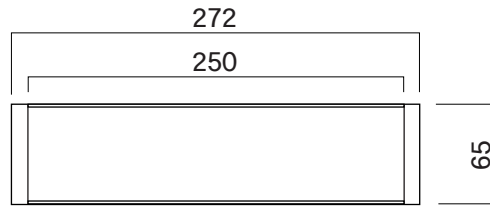

UN65S
UN65P

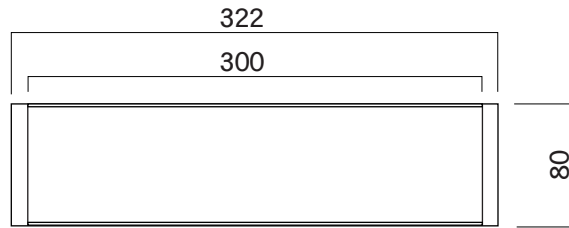
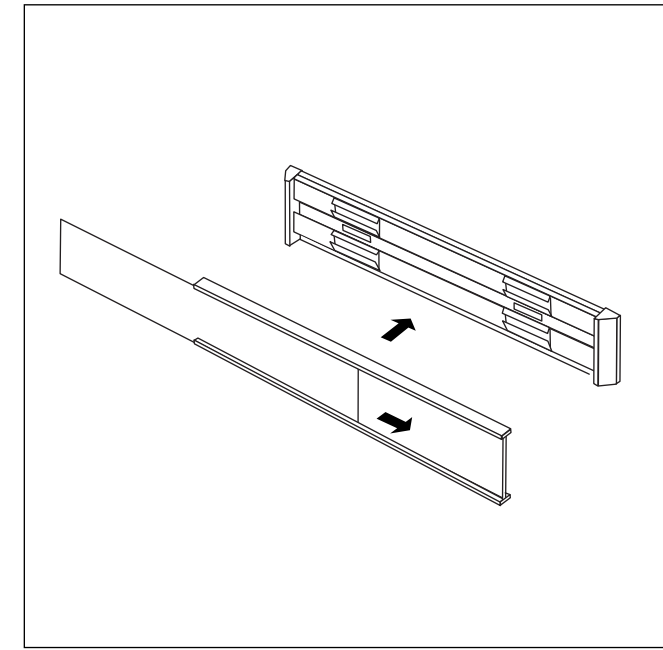

UN80S
UN80P

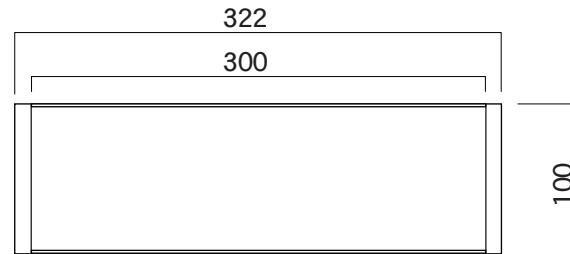

UN100S
UN100P

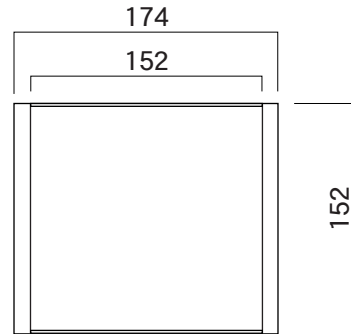

UN152S
UN152P

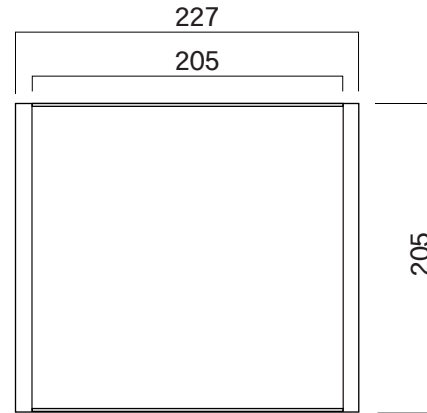

UN205S
UN205P

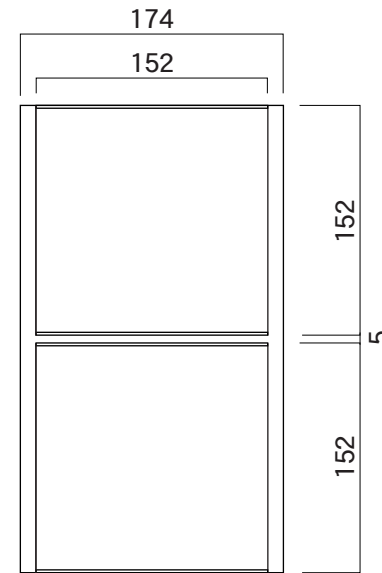

UN1522S
UN1522P

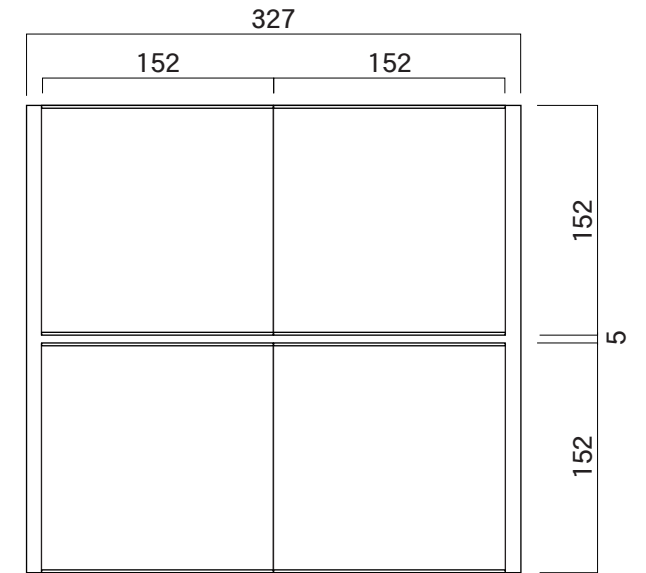

UN1524S
UN1524P

本 体:アルミ押出型材、アルマイトシルバー
表 示 面:S/ステンレスt0.8ヘアライン仕上
P/PET樹脂板t0.8透明

図面番号	図面名称	O-PIC	縮尺	1/5	承認	設計	担当
	No.	UNタイプ	設計年月日				