

FV61

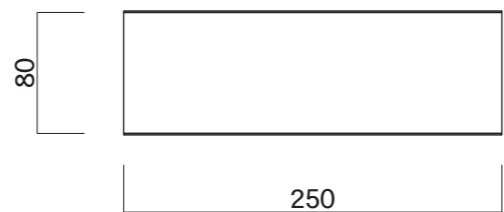

FV81

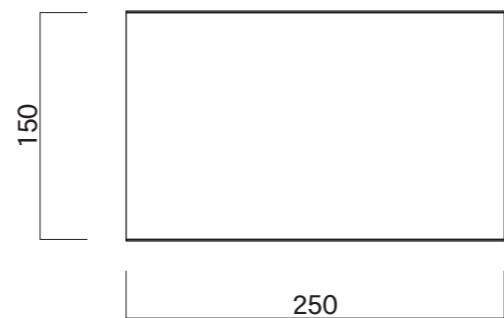

FV2515

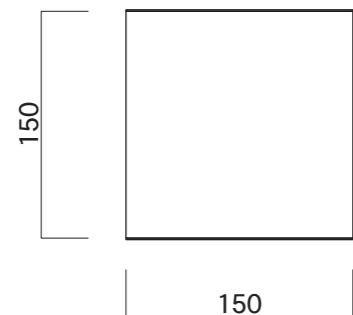

FV150

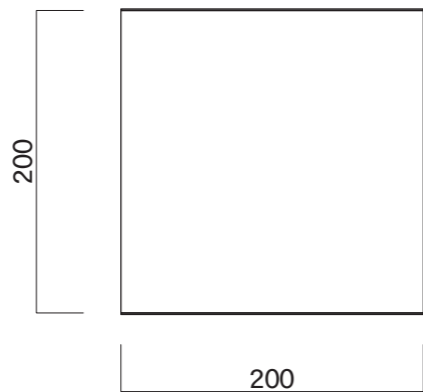

FV200

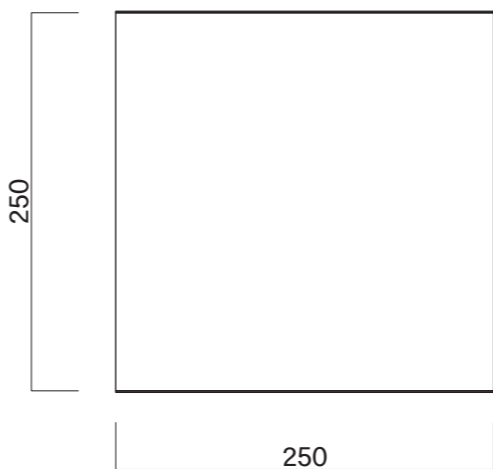

FV250

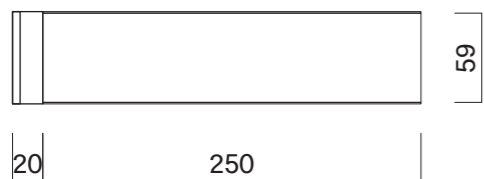
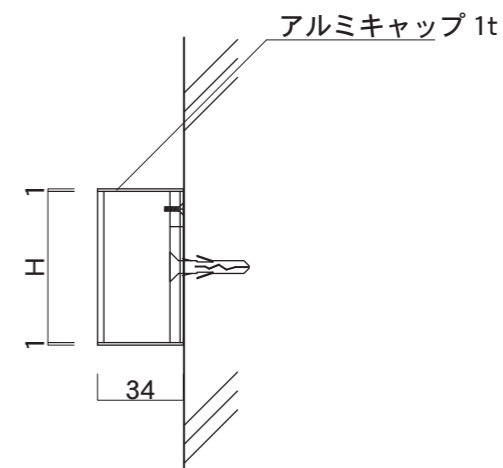
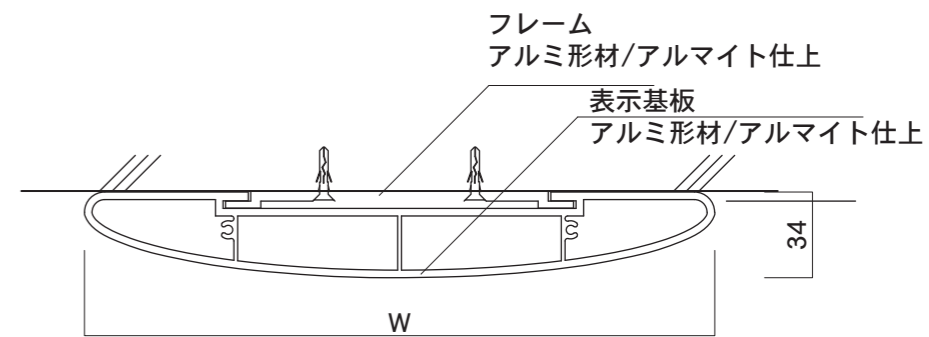

FVY61

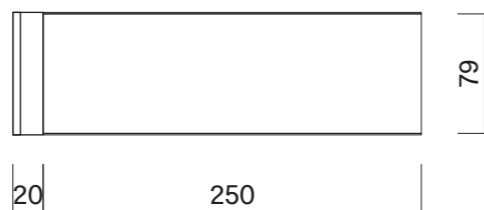

FVY81

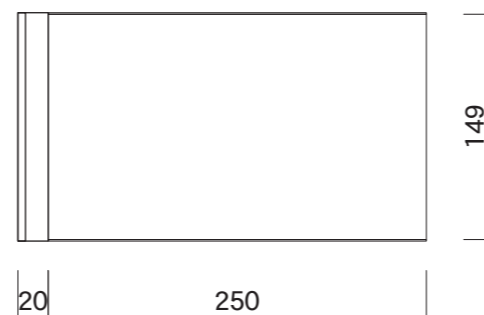

FVY2515

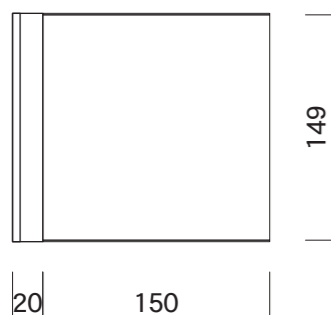

FVY150

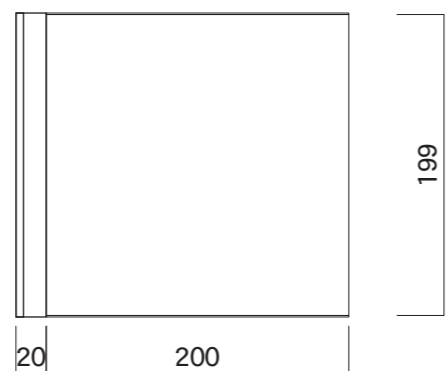

FVY200

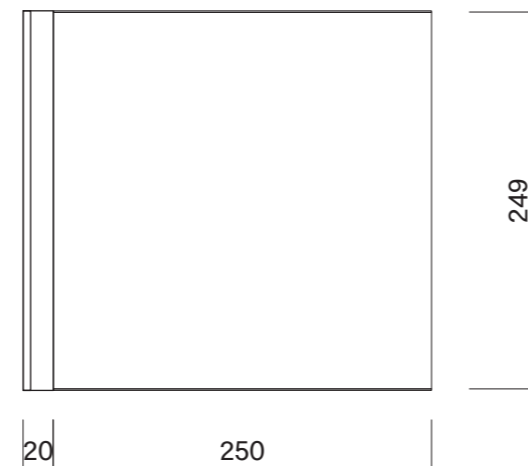

FVY250

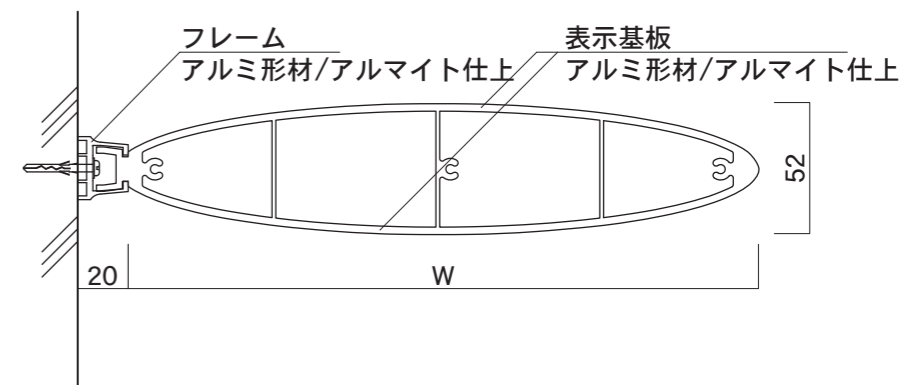

図面番号 No.	図面名称 F-PIC	縮尺 1/5・1/3	承認	設計	担当
	FVタイプ	設計年月日			